

Mower combinations

GMD 1023 F / GMD 1025 F
GMD 1011 / GMD 1051 TC
GMD 1030

FC 1025 F
FC 1015
FC 1030



www.kuhn.com



be strong, be **KUHN**



GMD 3123 F 3125 F 3525 F 2811 3111 3511 3511 RS 4011 4411 5251 TC 8730 9530 10030

FC 3125 F 3525 F 3115 8830 9530 10030

MAXIMISING OUTPUT. OPTIMISING FORAGE.



GMD mowers and FC mower conditioners help you achieve your output objectives. Farms have increasingly larger areas to harvest and optimal mowing periods are limited. That's why it's essential to work quickly and effectively, at the right time. You need to harvest top-quality forage to make sure your herd gets the best feed possible, and you can count on KUHN to provide you with high-performance, reliable and quality-producing solutions.

ENSURE A REGULAR CUTTING HEIGHT

An immaculate ground adaptation is an absolute precondition to obtain a regular cut and proper forage on rolling ground and slopes. The topic becomes all the more important, the wider the working width is. KUHN has risen to the challenge by proposing sophisticated technical solutions to achieve both a high vertical and angular travel range.

HARVEST THE BEST OF THE PLANT

KUHN large-width mowers and mower conditioners have some points in common to ensure that you cut all the forage and this of high quality: LIFT-CONTROL hydro-pneumatic suspension, OPTIDISC ELITE cutter bar, lateral offset options and more.

REFERENCES IN TERMS OF RELIABILITY

From the PROTECTADRIVE safety on the cutter bar to a hydraulic safety break-away... That's why they are the reference in the market!

KUHN'S GMD AND FC RANGES IN BRIEF:

	Working width (m)	Swath width (m)	Number of discs	Conditioning system
GMD 3123 F	3.10	1.40	7	
GMD 3125 F / 3525 F	3.10 / 3.50	1.00 - 1.50	7 / 8	
GMD 2811	2.67	1.70	6	
GMD 3111	3.10	2.30	7	
GMD 3511 / 3511 RS	3.51	2.80-1.40	8	
GMD 4011	3.95	3.30	9	
GMD 4411	4.35	3.70	10	
GMD 5251 TC	5.20	4.00	12	
GMD 8730	8.30 - 8.80	2 x 2.40	2 x 7	
GMD 9530	9.13 - 9.53	2 x 2.80	2 x 8	
GMD 10030	9.53 - 9.93	2 x 2.80	2 x 8	
FC 3125 F / 3525 F	3.10 / 3.50	1.20 - 2.00	7 / 8	- DIGIDRY pivoting steel fingers - SQUAREFLEX polyurethane rollers
FC 3115 / 3515	3.10 / 3.50	1.20 - 2.00	7	
FC 8830	8.33 - 8.73	2 x 1.45 - 2.10	2 x 7	
FC 9530	9.13 - 9.53	2 x 1.85 - 2.40	2 x 8	
FC 10030	9.53 - 9.93	2 x 1.85 - 2.40	2 x 8	

GMD 3123 F 3125 F 3525 F 2811 3111 3511 3511 RS 4011 4411 5251 TC 8730 9530 10030

FC 3125 F 3525 F 3115 8830 9530 10030

CONTOURING YOUR PLOT...

Your main goal is to produce as much milk and meat out of the basic ration? KUHN is at your side to achieve high quality forage with minimum soil levels and rich in energy and nutrient. On the new GMD and FC triple mowers, special features are built in to facilitate ground contouring and thus improve the cutting quality and leave an undamaged grass stubble.



FLEXIBLE FRONT UNITS THAT ADAPT TO THE LAND

The frame of the GMD and FC 3125/3525 front mowers integrates a suspension unit, enabling the mowing unit to put large travel ranges into practice. We are talking about an angular movement range of 30° and a vertical displacement of nearly 70 cm, while the ground pressure is kept constant all the way! The unit's pendulum-type articulation serves of course as basis for the high travel ranges.





THE MACHINE YOU NEED!

IMPRESSIVE TRAVEL RANGE OF REAR UNITS

The GMD and FC rear units follow virtually all ground contours.

The following list of features underlines this:

- pendulum-type articulation of units,
- hydraulic side shifting of 20 cm,
- a vertical travel range of nearly 50 cm,
- an angular flexibility from $+13.3^\circ$ to -8.1° at 50 cm overlapping.

Impressive numbers you say: You can be sure that KUHN has done everything for improving your forage!



NARROW SWATHS ON DEMAND

The front mowers' swath width can be reduced to a minimum of 1.00 to 1.20 m, if needed in order not to drive over it with the tractor wheels. In this way the forage is not run flat and contaminated by soil.

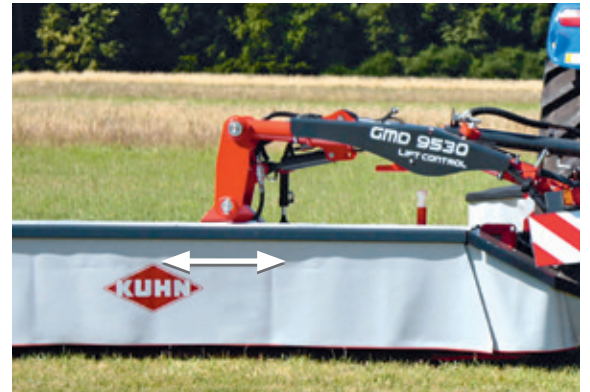

NOTHING IS LEFT UNCUT

For a clean and complete cut on slopes and in sharp bends, the mower units can be shifted laterally by 20 cm to create an increased overlapping between the front and rear units. Depending on the model combination, overlaps from 30 cm up to 70 cm are possible. The driver can modify the working width during work from the cab. This feature is a real benefit for tractors with wide tracks or large wheels.

GMD 3125 F 3525 F 2811 3111 3511 3511 RS 4011 4411 8730 9530 10030

FC 3125 F 3525 F 3115 8830 9530 10030

LIFT-CONTROL AND NON-STOP SYSTEMS:

Your company has to be profitable in spite of daily challenges:

- Weather windows are shorter and shorter.
- Your plots are bigger and bigger or further away.
- You set your standards higher, for you and your customers.

You can improve the quality of your forage and reduce downtime by using the LIFT-CONTROL suspension system and the NON-STOP active safety device.

THE LIFT-CONTROL SYSTEM: SMART KINETICS

The mowers in this range come with an exclusive system that combines LIFT-CONTROL suspension with NON-STOP safety. The position of the mower unit and cutter bar adapts to plot conditions resulting in impressive ground following:

- (1) Mower-unit-suspension cylinder.
- (2) NON-STOP break-away safety cylinder.
- (3) Pivot axis strategically positioned near the centre of the machine (4).

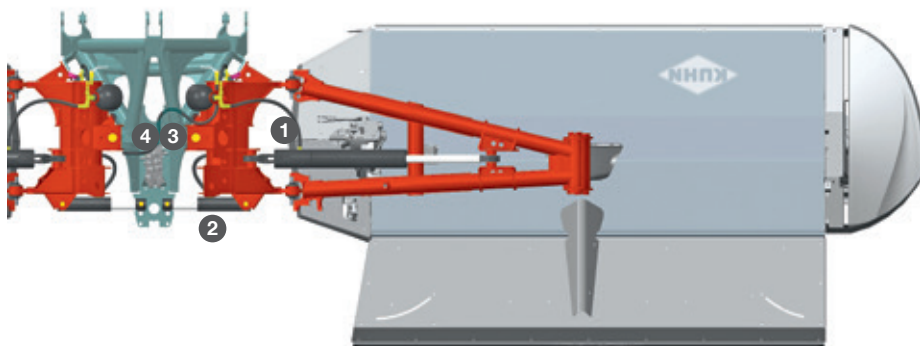

SIMPLY GREAT FORAGE!

Did you know that you can save concentrates worth 89 €/ha per year, just by reducing the impurities in the forage from 4 to 2 %*? We are at your side to help you produce forage of top quality to realise according gains.

We would like to pass on our know-how in forage production, gathered during several decades of producing hay/silage making implements. We provide advice for you to produce first-class animal feed. We help you to understand the strong points of our machines in order for you to use them in an optimal way to preserve the quality of your forage.

With the KUHN expertise, you will harvest forage with...

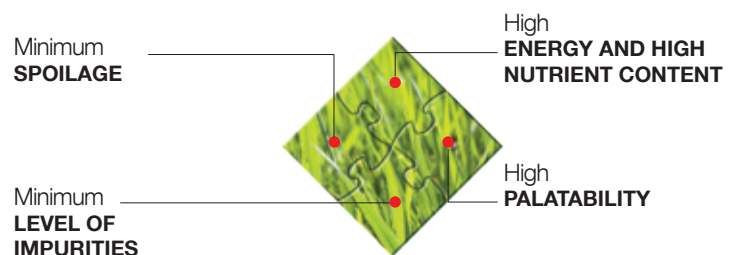

Find all our expertise on forage.kuhn.com



GROUND FOLLOWING: PRECISE, SIMPLE ADJUSTMENT

In-cab control of accumulators enables you to adapt ground pressure to mowing conditions with high precision.

When the cutter bar glides across the ground it is subjected to rearward stress. With this system, when stress increases, mower-unit ground pressure is reduced.

On wet land, low pressure prevents clogging and forage contamination.

Grass stubble is preserved. Skid-wear and fuel consumption are reduced.

Pressure can be increased in dry conditions for better contact with grass stubble.

NON-STOP MOWING

The best way to save time and money is to reduce downtime. In the event of impact or a false move, up to an 11° rearward angle, the LIFT-CONTROL system will ensure constant ground pressure. The mowing unit can swivel 25° to the rear and pass over an obstacle if it comes into contact. The unit then returns to its initial working position automatically and NON-STOP. It is no longer necessary to reset the system or move back to continue mowing.

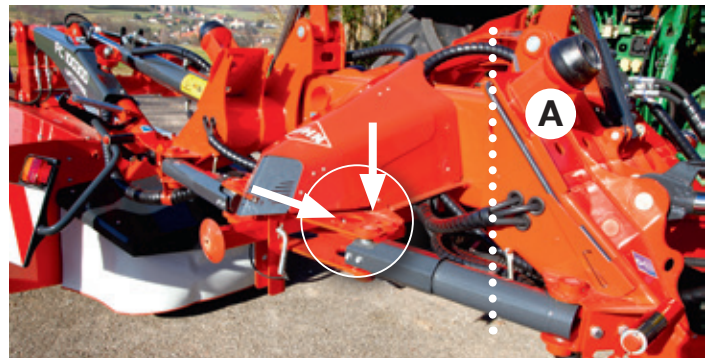

Even more benefits:

- Highly effective against inner-disc impacts. The pivot point of the arm has been distanced as far as possible from the first discs (**A**).
- Independent suspension on each mowing unit prevents one mowing unit from being forced forward when the other one clears an obstacle.
- The break-away system can be adjusted to suit your working conditions. The force required for break-away can be increased (high-speed mowing or difficult conditions).

GMD 3123 F 3125 F 3525 F 2811 3111 3511 3511 RS 4011 4411 5251 TC 8730 9530 10030

FC 3125 F 3525 F 3115 8830 9530 10030

OPTIDISC ELITE: THE OPTIMUM CUT!

The OPTIDISC ELITE cutter bar was developed in partnership with the people who use it; farmers. It combines cutting quality, reliability and operating comfort.

It meets and surpasses the requirements of large farms and contractors:

- Lubricated for life
- Perfectly compatible with high-powered tractors.

IMPECCABLE CUTTING QUALITY!

The profits that come from livestock farming are dependant on feed reserves stored in silos, bales or bulk. The aim is simple: to produce as much meat or milk as possible from the basic feed ration by optimising palatability. In order to do so, plant stubble has to be preserved and forage contamination from impurities kept to a minimum. KUHN has perfected the technical features of the mowers so that you get the best from your forage and increase your profits.

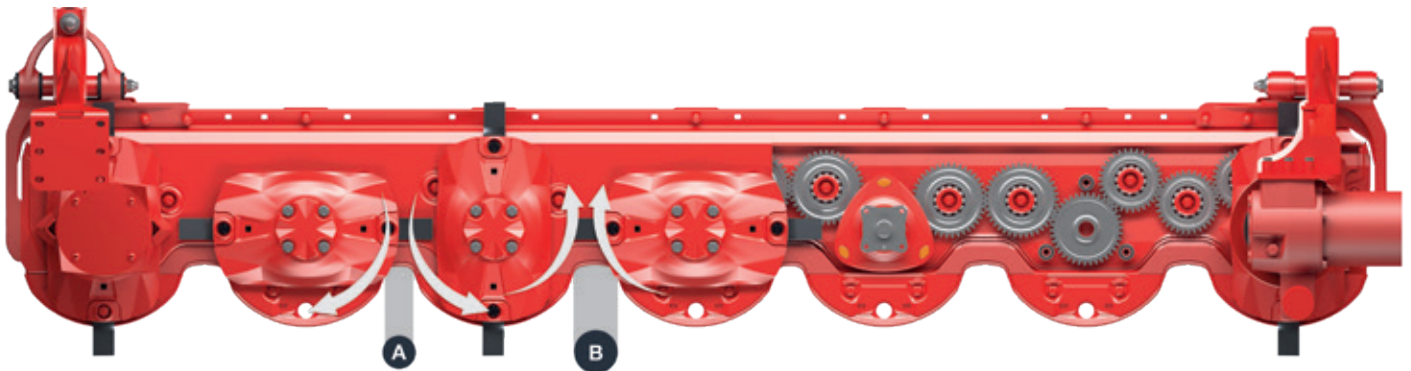

MINIMUM DISTANCE: A CLEAN CUT

The distance is reduced at the point where the discs diverge **(A)** to increase knife overlap. This results in a clean cut even when the grass is short or light.

MAXIMUM DISTANCE: EASY CROP PASSAGE

The distance is increased at the point where the discs converge **(B)** to provide more space for the crop to pass through. Cut crop is carried away quickly without hindering the work of the mower.



EXCLUSIVE

GLIDE ACROSS GRASS STUBBLE

In wet and sticky conditions earth can build up in front of the cutter bar; except with OPTIDISC ELITE! It comes with special skids that slide across the ground and preserve grass stubble. Yet another advantage for forage quality and a uniform cut, especially in difficult conditions.



TOP-OF-THE-RANGE COMPONENTS REINFORCE THE MOST PRECIOUS PARTS OF THE CUTTER BAR

EXTREME RELIABILITY AND HOLD

Top-of-the-range components reinforce the most precious parts of the cutter bar:

- Special disc-bearing station with a double row of angular contact ball bearings.
- Large-diameter gear wheels in high-precision forged steel with 3 cogs engaged.
- Discs with forged and treated cups across the surface area.
- Disc skids in treated steel with the option of adding a protective layer (screw on).
- PROTECTADRIVE safety.

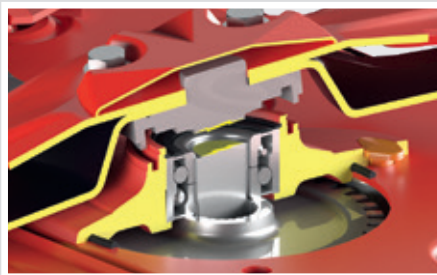

SAFETY

PROTECTADRIVE: PROTECTION AND COST REDUCTION

In the event of a violent impact between a disc and an obstacle, the shaft holding the disc can shear just above the bearing thanks to a carefully dimensioned shear groove. The toothed wheels are protected. In less than 15 minutes, the machine is operational again and at a very low repair cost.

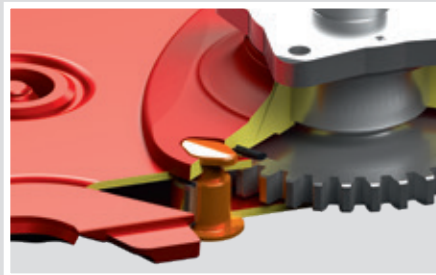

EXCLUSIVE

EXTRA RIGIDITY WHERE IT COUNTS!

Disc-bearing stations are attached by long bolts that pass through the entire cutter bar. This eliminates any risk of the mounts being torn out of the cutter bar in case of impact. The disc-drive pinion is held in place with this highly reliable system that reduces repair costs.

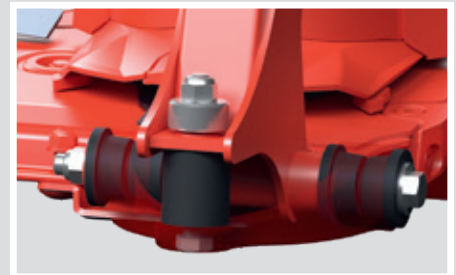

EXCLUSIVE

LONGER MACHINE LIFE

Shock absorbers are integrated in the connection between cutter bar and chassis. The structure of the machine is less affected by impacts, especially when working at fast ground speeds.



FAST FIT: KNIVES COMPLETELY SECURED

Mowers are equipped, as standard, with the FAST-FIT quick release knife system. A powerful leaf spring provides constant pressure to the knife retainer for extra safety. It takes just a few moments to replace knives.



KNIVES FREE TO ROTATE

For higher cutting quality and a longer life, the knives rotate freely 360°.

CUTTING AND CONDITIONING: DOUBLE QUALITY

Fast mowing, efficient and easily adaptable conditioning as well as wide spreading are the ingredients to improve work output and forage quality

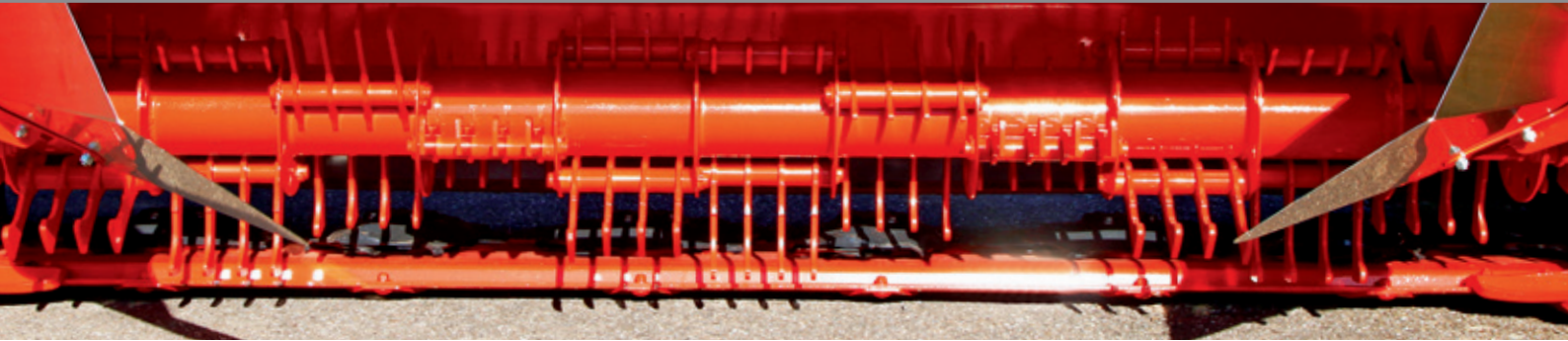

ROTOR WITH PIVOTING FINGERS IN DIGIDRY STEEL MADE FOR DIFFICULT CONDITIONS

The 540 mm rotor with pivoting steel fingers ensures exceptional conditioning:

- Uniform dry-out over a large width, even in difficult conditions.
- Reduced power requirement for heavy or long forage.
- Pivoting fingers that prevent picking up foreign bodies.
- Forage delivery into a swath or wide-spreading across the whole working width.



ROTOR SPEED: IT'S YOUR CHOICE!

The conditioner is easily adjusted to adapt to forage type with a two-speed central lever. Reduce speed for delicate crops and lower fuel consumption; on late jobs with less forage for example (755 min⁻¹). Increase speed for dense forage (1,000 min⁻¹).



EXCLUSIVE

BUILT-IN ROTOR PROTECTION

The rotor conditioner's drive shaft is protected by a shear bolt. The machine and drive system are protected should a foreign body pass through.





SQUAREFLEX ROLLERS IN POLYURETHANE: FOR DELICATE FORAGE

Integrating legumes in the feed reduces the need to buy concentrates, but only if the leaves remain with the cut crop.

Tests carried out by Arvalis (French agronomic institute), the Chamber of Agriculture and the FD machinery cooperative in 2016 highlighted the advantages of using rollers:

- 100 euros / ha / cut of savings
- over 80% of DM by the second evening compared to the third evening with other methods.

Definitely worth thinking about the purchase of a conditioner with rollers!

Specific roller treads in polyurethane grip the crop with a regular movement.

A large-roller diameter creates effective forage evacuation to the rear with no build-up.

ARVALIS
Institut du végétal

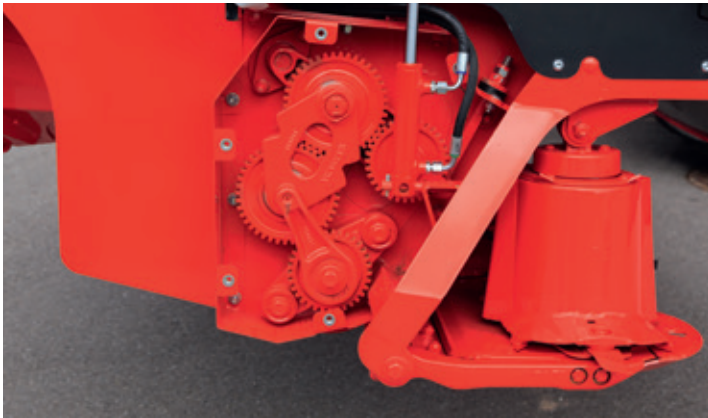

PERFECT SYNCHRONISATION

The lower roller is driven by two gearboxes and maintenance-free transmission. The upper roller is driven by a specific gear wheel. Synchronisation is perfect and maintenance time is reduced.



EASY ADJUSTMENTS

Pressure can be adjusted between the rollers via an easily accessible adjustment screw. The distance between the rollers increases to let foreign bodies through.



GMD 3125 F 3525 F

FC 3125 F 3525 F

HIGH-PERFORMANCE OBJECTIVE

FRONT MOWERS AND MOWER-CONDITIONERS WITH EXCEPTIONAL FEATURES:

- Hydro-pneumatic LIFT-CONTROL suspension in the mowing unit for perfect ground adaptation.
- Maintenance-free OPTIDISC ELITE cutter bar for an optimum cut.
- PROTECTADRIVE safety against obstacles.
- FAST-FIT quick-release knife system.
- Easy adjustments for user comfort.
- The choice between a conditioner with pivoting steel fingers and a roller conditioner.
- Strong, reliable (no A frame) cat. 2 attachment which provides high clearance for the PTO shaft.

EXCLUSIVE

A FUNCTIONAL DESIGN

The headstock is not only attractive it is functional too. The compact frame improves visibility for mowing as well as on the road. The coupling frame integrates a suspension unit which ensures exceptional ground adaptation.



DYNAMIC SUPPORT ARMS

The highly specific kinematics of these machines include two strong lower connecting rods mounted on extra-large ball joints. The connecting rods are attached to the tractor in a lower position than at the front. This creates dynamic stress during operations which produces a lift-effect on the mower unit and makes a considerable difference to ground-contour following in hilly areas.

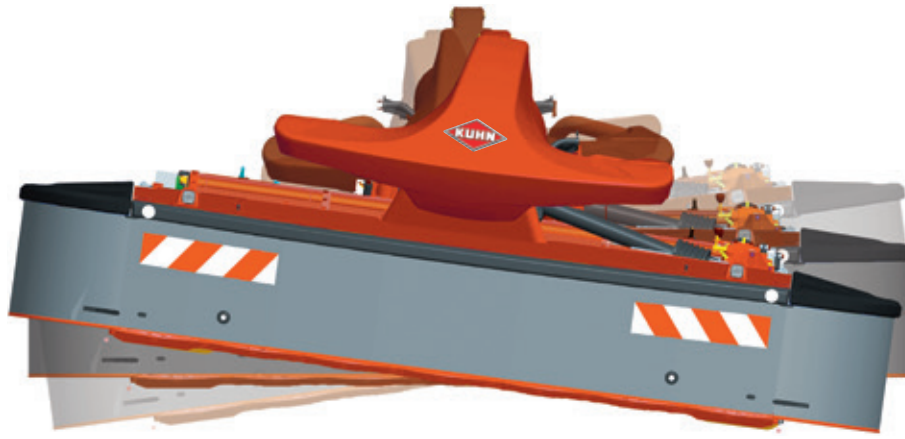

GREAT TERRAIN FOLLOWERS

Our front mowing units are flexible enough to smoothly adapt to any changes in terrain. They are often subject to extreme stress which is why GMD / FC front units feature pendulum-type articulation and have multi-directional mobility. They can oscillate from left to right at an angle of up to 30° and have vertical offset of nearly 70 cm!

QUICK AND EASY SETTINGS

GMD and FC front units have easily-adjustable ground pressure with hydraulic suspension. An integrated cylinder lifts the mower units at headlands so no strain is put on the tractor's front hydraulics. FC front models are equipped with a lever to select conditioning speed (755 or 1,000 min⁻¹) simply.

NARROW SWATH, PROTECTED FORAGE

GMD front mowers include a swath drum on either side to prevent the wheels of the tractor from crushing the forage. The swath drums gather the crop together to reduce the width of the swath to between 1.00 and 1.20 m.

The conditioner helps to reduce swath width to 1.20 m if required, on FC models.

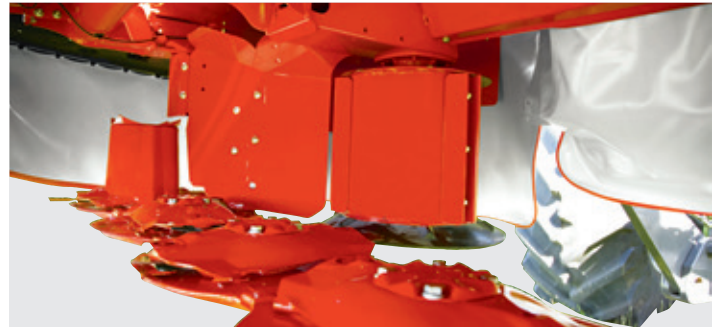

WIDE AND MODULAR OVERLAP

For a clean cut on slopes and bends, the overlap between the front and rear units can be adjusted hydraulically between 30 and 70 cm (depending on the model combination) - even while driving. This is a real benefit for tractors with wide tracks or large wheels.

FLEXPROTECT: FLEXIBLE PROTECTION

Gone are the days of damaged side covers after hitting an obstacle! Polythene side covers bend without breaking or damaging the mower, and then they return to their initial shape.

GMD

3123 F

A GO-ANYWHERE TOOL

The new GMD 3123 F front mower is ideal for farms looking for a lighter machine adapted to tractors from 80 hp. Its compact design and lighter weight enable it to operate in hilly areas as well as flat. The mower unit follows ground contours effectively thanks to its +/- 12° pendulum-type articulation. Two swathing discs come as standard to produce an average swath width of between 1.2 and 1.4 m.





A LIGHT AND COMPACT MOWER

The GMD 3123 F is the perfect machine for medium-sized tractors. Its lighter weight and reduced overhang put less pressure on the front axle, and this contributes to great ground hugging. Two suspension springs linked to the tractor reduce pressure on the ground and preserve the sward. A powerful leaf spring stabilises the mower unit perfectly during headland turns and on the road.

BENEFIT FROM GREAT MOWING QUALITY

The machine is equipped with the OPTIDISC ELITE cutter bar known for its robustness and perfect mowing in all conditions. The special arrangement of the direction of rotation optimizes cutting quality, transfer to the center of the machine and swath formation.



FLEXIBLE PROTECTION AGAINST IMPACTS

KUHN's exclusive flexible external guard, FLEXPROTECT, protects the cutter bar when mowing along field edges or next to trees. It can bend and return to shape; a feature that saves on repair costs. It is deployed manually, as standard, with an option for hydraulic control to assist in small plots.

GMD**2811****3111****3511****3511 RS**

THE COMFORT RANGE

Working quality and a compact design are the features that characterise GMD 2811, 3111 and 3511 mowers. These models can work anywhere in any conditions. The terrain-following capacities of the LIFT-CONTROL system and the mower unit's pendulum-type articulation will meet the most demanding requirements by effectively preventing forage contamination.



COMFORTABLE ATTACHMENT SOLUTION

When attaching the mower to the tractor, there is no need to change the length of the tractor's linkage arms to balance the mower's weight. When unfolding the machine to working position, cut height is automatically set to 45/50 mm (1.77/1.95), no intervention needed.



ADAPTABLE TO LARGE TYRE TRACTORS

With an offset of 19 cm (7.48"), GMD 1011 models can easily be adapted to large tyre widths. This optimises overlap when combined with a front mower.



SAFE AND EASY TRANSPORT

The lengthways transport position of these models provides an extensive visibility to the back. The unit is also parked in this position making it easy to back into a narrow barn. A wide two point parking stand provides stability when the mower is in storage.



CENTRAL ARTICULATION. PERFECT BALANCE.

A suspension system's performance is compromised if the weight distribution across the ground is not uniform. With the LIFT-CONTROL range the mowing head is suspended at its centre of gravity. Thanks to this central pendulum articulation, the unit runs smoothly and stable even over very rough fields. It provides excellent ground contouring, thus protecting the grass stubble and minimising impurities in the forage. The major pivot angle enables obtaining a high quality cut in most versatile conditions.



CONTROL WITH CONFIDENCE

The mowing head is easily and precisely controlled with minimised hydraulic requirements to reduce reaction times. A single hydraulic valve is all that you require to raise and lower it. A minimum lift clearance of 40 cm (15.75") easily clears obstructions and previously cut crop.

GMD 2811 3111 3511 3511 RS

**MODERN.
PRACTICAL.
RELIABLE.**



**KUHN DESIGNERS
THINK PRACTICAL**

A modern design will never be the most important argument for you to choose your model. But it is undeniable that the new bodywork design of the GMD 1011 LIFT-CONTROL mowers is appealing and integrates elegantly the box for spare knives.



PROVEN KUHN RELIABILITY!

The structure of the chassis, beams and articulations are worthy of a KUHN construction: strength and longevity is ensured.



EVEN LESS SERVICING

With a 100 hour maintenance schedule, greasing the secondary PTO shaft is no longer a daily activity.



GMD 3511 RS LESS GRASS CONTAMINATION

The GMD 3511 RS is a specific mower for delicate forage as well as grassland regions with predominantly wet conditions or marshy soils. In order that the cut crop is not overrun by the tractor wheels, the swath width can be reduced to approx. 1.40m (4'3"). This way it is not pressed on the ground and thus not subject to additional contamination by soil.



be strong, be **KUHN**

KUHN PARTS

Designed and manufactured to rival time



KUHN foundries and forge as well as a high-level manufacturing process allow the production of spare parts to defy time. You can truly rely on our know-how and our genuine parts. Farmers benefit from our client support and logistics services via any KUHN PARTS warehouse, which provide quick and reliable repair solutions in cooperation with your nearest authorised KUHN dealer.



GMD

4011

4411

MAXIMUM PRODUCTIVITY IN A MOUNTED MOWER

GMD 4011 and 4411 models open the way to performance levels previously not thought possible. Mowing rates of up to 5 hectares (12 acres) an hour can be reached.

For even higher output, just add a GMD 3123 F, GMD 3125 F or GMD 3525 F front mower with working widths of 3.1 m and 3.5 m to bring the total working width to 7.6 m.

An additional 19 cm offset is possible on GMD 4011 and GMD 4411 models.

This provides the ideal overlap between the front and rear mower.

The level of productivity obtained almost matches certain triple combinations, but at a considerably lower cost.





AT EASE ON HEADLAND AS WELL AS ON THE ROAD

Both mowers provide a lift height of at least 40 cm (15.75") controlled by one double chamber hydraulic valve from the tractor, which is located under the beam. There is no need to also raise the tractor's 3-point linkage to achieve sufficient lift on headland. While one chamber is used for raising the cutter bar, the other is connected to the accumulator and therefore provides a performing suspension at transport and in headland turn position.



EXCLUSIVE

SUSPENSION FOR TRANSPORT AND AT WORK

With high speed transport now being the norm, KUHN has installed a hydro-pneumatic suspension system on the GMD 4011 and 4411 mowers. This system absorbs bumps and jolts on the road which makes the tractor more stable for better control and less mechanical stress. This system is also appreciated when making headland turn manoeuvres.



CLEAN FORAGE WITH TWO SWATHS

An optional swath divider on the GMD 4411 model makes it possible to deliver cut forage in two swaths. Tractor wheels roll between the swaths easily without damaging or contaminating the cut crop.

GMD 5251 TC

MOWING UP TO 7 HA PER HOUR ALSO WITH LOW-TECH TRACTORS

The increase in grassland to mow necessarily leads to an adaptation of the equipment used. With the new trailed large width central drawbar disc mower GMD 5251 TC, KUHN offers a cost-effective alternative with regards to front-rear mowing units coupled to tractors of a certain size and necessarily equipped with a front lift linkage and PTO-shaft. This high work output model features a working width of 5.20 m and is intended for medium power tractors as from 110 - 120hp only.





FEATURES FOR HIGH WORK OUTPUT AND DRIVING COMFORT

This trailed machine combined with the central drawbar increases work output considerably. The GYRODINE swivel hitch is renowned for its manoeuvrability. It provides unrivalled operating comfort.



GRASS STUBBLE PRESERVED

The large-width wheels (400/60-15.5) are designed not to run over the forage. They reduce the pressure of the unit on the ground thereby protecting grass stubble and improving regrowth.



HUGGING THE TERRAIN

Forage quality and nutritional value are preserved thanks to the suspension with four powerful springs and mower unit kinematics with upward travelling connecting rods that ensure perfect ground contour following.



RAPID AND EASY TRANSPORT

Transport-work position setting is carried out in less than ten seconds. The transport wheels set in forward position and road travel dimensions below 2.90 m (9'6") make the GMD 5251 TC disc mower a highly manoeuvrable machine for accessing plots and very safe for transport also at high groundspeeds.



A WELL DELIVERED SWATH

Forage is delivered in one swath of approximately 4 m width facilitating drying and the later tedding process, with the possibility to divide it in the middle depending on the setting of the flow dividing plates.

GREAT OUTPUT WITH MINIMUM ENERGY CONSUMPTION!

High output accessible to all, with minimal power requirement: the great benefits of this triple combination. Weighing less than 1,900 kg, it can be used with tractors from 120 hp, depending on conditions. Being equipped with LIFT-CONTROL hydro-pneumatic suspension and the OPTIDISC ELITE maintenance-free cutter bar, the GMD 8730 features convincing solutions for increased comfort and time savings.

LIFT-CONTROL: SAVINGS ALL ALONG THE LINE



Because time is money, adjusting weight-reducing pressure takes just a few seconds! The folding cylinders include an extra chamber connected to nitrogen balls. In this way, it is easy to adjust the pressure to harvesting conditions. The Non-Stop hydraulic safety provides flexible individual protection and reactivates the two mowing units after having passed the obstacle.

It is when mowing on slopes that the LIFT-CONTROL system shows all its advantages and is reflected in a distinct reduction of fuel consumption and higher working rate.





INDIVIDUAL LIFT OF MOWING UNITS AS STANDARD

When working, you only have to handle one valve to lift the front-mounted mowing unit and one for the rear units.

The possibility of lifting both rear mowing units individually is a big advantage on wedge-shaped fields and allows quick and easy manoeuvres. The concerned unit is put into transport position by manipulating a two-way hydraulic valve.

THE MOWING UNIT WHICH SUITS YOUR NEEDS...

Three positions (1, 2, 3) are available for mounting the mowing units on the arms: Depending on working conditions (slope, size of field, width of front unit, etc.), you can choose the total cutting width or more overlap between front and rear-mounted units.

SPACE-SAVING STORAGE

It's the compact dimensions that stand out, when the GMD 8730 triple gang mower is folded for storage. The machine can be parked vertically without additional equipment necessary. Be sure: The machine fits in almost every shed.



LARGE-WIDTH DREAMS...

Output is the factor that counts on large operations, but it's the extra MJ of energy and avoided percentage of soil in the forage that makes the real difference also for large farms and contractors. The working widths of 9.13 to 9.53 and 9.53 to 9.93 m for the two models respectively, speak for themselves, the following features adding the cherry to the cake:

- a special frame design for an unmatched ground adaptation;
- a central pendulum-type articulation of the mowing unit;
- a large and flexible cut overlap between front and rear units;
- the maintenance-free OPTIDISC ELITE cutter bar for an optimum cut;
- PROTECTADRIVE safety and FAST-FIT quick-release knife system;
- the hydro-pneumatic LIFT-CONTROL suspension of the mowing unit.



STAY RELAXED IN THE CAB

The KFA11 control box makes machine adjustments and control so much easier.

The cab-controlled functions include:

- folding/unfolding.
- Individual lift of mower units.
- Mower unit ground pressure by LIFT-CONTROL hydro-pneumatic suspension.



SEPARATE HYDRAULIC LIFTING OF UNITS

The possibility of lifting both rear mowing units individually via hydraulic cylinders is a big advantage on wedge-shaped fields and allows quick and easy manoeuvres. This can be done directly from the cabin via KFA11. At the same time the system ensures a reduced ground pressure: beneficial to plant cover, cutter bar wear and power input.



ROAD TRANSPORT AT EASE

Transporting a butterfly combination in upward folded position positions it closer to the tractor.

This has clear advantages:

- Compact on the road (reduced length).
- Centre of gravity close to the tractor.
- Reduced load on the rear tractor axle.



PRACTICAL STORAGE POSITION

Two parking stands are delivered as standard with the machine.

They enable you to park the machine in folded position, thus considerably saving storage space.

THE COMBINATION THAT MAKES A DIFFERENCE!

KUHN has combined conditioner, LIFT-CONTROL suspension and vertical folding, for the first time in one machine, to create the new FC 3115 mounted mower conditioner. These new models of mower conditioners have a working width of 3.10m. They are designed for forage farms and contractors, and can be used with a front mower to increase work output.

THESE NEW MOWER CONDITIONERS BOAST ALL THE FEATURES THAT HAVE MADE KUHN'S MOWER RANGE SUCH A SUCCESS:

- Mower unit with LIFT-CONTROL hydro-pneumatic suspension and NON-STOP safety for excellent ground contouring
- Impressive cutting quality by the OPTIDISC ELITE maintenance-free cutter bar
- PROTECTADRIVE safety system to manage obstacle-impact
- FAST-FIT knife attachment system
- Operating comfort with simple settings
- The choice between a conditioning system with pivoting steel fingers or roller.



OPTIMISED LINKAGE SYSTEM FOR YOUR TRACTOR

No need to change the length of your tractor's hitch arms. Linkage is extremely secure with coupling yokes. Your mower unit is even more stable at work and on the road. It is possible to optimise the position of the mower unit to the tractor or front implement with the 15 cm-offset feature.



MORE COMPACT AND STABLE AT WORK AND ON THE ROAD

The mower conditioner folds 126° making it highly compact for transport. Optimum machine-tractor weight balance provides excellent stability on the road and between plots.

JOBS ON SLOPING PLOTS OR WITH MEDIUM-SIZED TRACTORS?

An optional support system and counterweight relieve stress on the hitch arms.



MAINTENANCE COST SAVINGS

Whatever conditioning system you have opted for, your maintenance costs will be lower. The OPTIDISC ELITE cutter bar is maintenance free; no oil change is required.

If you go for a finger conditioner, the main gearbox and drive will only need an oil change every 500 hours or once a year. If you decide on a SQUAREFLEX roller, the drive gearboxes will require no maintenance.

GMD specifications

	3123 F	3125 F	3525 F	2811
Working width per cutting unit (m)	3.10	3.10	3.50	2.67
Possible working widths of combinations (m)	-			5.55*
Overlapping front/rear unit (cm)	29 - 44 - 55 (GMD 8730) 30 - 50 (GMD 9530)		50 - 70 (GMD 9530) / 30 - 50 (GMD 10030)	
Swath width (m)	1.30 - 1.40	1.00 - 1.20		1.70
Swathing	2 swath wheels	2 driven drums		2 swath wheels
Attachment	3 point- Cat. 2			
PTO speed (min ⁻¹)	1,000			540
Primary PTO shaft	1 3/8" - 6 splines with friction clutch	1 3/8" - 6 or 21 splines		1 3/8" - 6 splines
Free wheel				
Cutter bar				
Number of discs with safety skids made of hardened steel	7	7	8	6
Gearwheel protection				
Suspension	By spring			
Ground adaptation	Pendulum-type articulation	Swivel rods		
Transport width (m)	3.00	2.99	3.48	
Transport height (m)				
Side guards				
Machine storage	Flat			
Lighting and signalling				
Min. PTO power requirement (kW/hp)	32/43		36/49	27/37
Tractor hydraulic requirements	-	1 SA		
Tractor electric requirements				
Weight (kg)	745	1,105	1,180	845

◆ as standard

* With linkage in minimum overlap position. Add 20 cm if 3.50 m front mower.

** Depending on crop.

POWERFUL HARVESTING SOLUTIONS

The forage harvesting chain is only as strong as its weakest link so it's important that all machines work in harmony. The KUHN ForageXpert app can assist you in optimising your harvest system with your existing equipment. The app helps you find the mower, mower conditioner, tedder and rake that are best adapted to your existing forage machines.

Available on the Apple Store and Google Play.

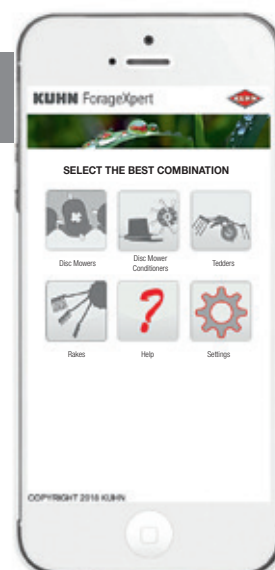

Triple gang disc mowers

3111	3511	3511 RS	4011	4411	5251 TC	8730	9530	10030
3.10	3.51		3.95	4.35	5.20	-		
5.98*	6.38*		6.83*	7.23*	-	8.80 - 8.50 - 8.30	9.53 - 9.13	9.93 - 9.53
22 - 41 depending on attachment and with 3.10m front tool 45 - 64 depending on attachment and with 3.50m front tool					-	29 - 44 - 55 (with 3.10m front tool)	30 - 50 (GMD 3125 F) / 50 - 70 (GMD 3525 F)	30 - 50 (GMD 3525 F)
2.30	2.80	1.30	3.30	3.70	4.00 - 4.40	2 x 2.40	2 x 2.80	
1 outer wheel		2 swath wheels	1 outer swath wheel		2 swath shields	1 outer swath wheel on each side		
			3 point- Cat. 3		Gyrodine headstock, 2-point with pivot - 2-point, cat 2	3 point- Cat. 2	3 point- Cat. 3	
540 or 1,000		1,000			1,000			
1 3/8" - 6 or 21 splines						1 3/8" - 6 or 21 splines	1 3/8" - 6 or 21 splines with friction clutch	
Integrated in the side gearbox					Integrated in the central gearbox	Integrated in the side gearboxes		
OPTIDISC ELITE								
	8		9	10	12	2 x 7	2 x 8	
PROTECTADRIVE system								
LIFT-CONTROL hydro-pneumatic suspension					By spring	LIFT-CONTROL hydro-pneumatic suspension		
LIFT-CONTROL hydro-pneumatic suspension					Integrated suspension unit	Pendulum-type articulation		
1.70	1.75	2.00		2.90	2.99	2.95	3.35	
-						3.65 - 3.75 - 3.90 depending on chosen overlap	3.92	
FLEXPROTECT soft side guards								
Flat					In transport mode	Flat or folded vertically		
◆								
32/43	36/49	41/55	45/61	54/73	90/122	99/135	104/141	
1 SA + 1 DA					2 DA	1 SA + 1 DA	2 DA	
1 7-pin plug					1 7-pin plug and ISO 1 3-pin plug			
900	950	980	1,085	1,120	3,000	1,910	2,300	2,350

SIMPLY GREAT FORAGE!

Did you know that you can save concentrates worth 89 €/ha per year, just by reducing the impurities in the forage from 4 to 2 %*? We are at your side to help you produce forage of top quality to realise according gains.

We would like to pass on our know-how in forage production, gathered during several decades of producing hay/silage making implements. We provide advice for you to produce first-class animal feed. We help you to understand the strong points of our machines in order for you to use them in an optimal way to preserve the quality of your forage.

*Source: Agricultural chamber Weser-Ems, Germany.

**With the KUHN expertise,
you will harvest forage with...**

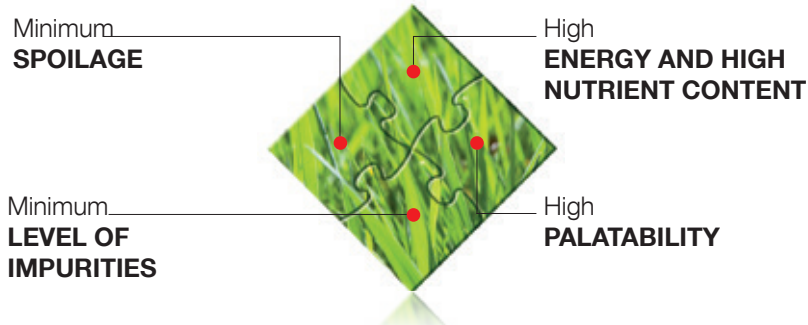

➔ Find all our expertise on forage.kuhn.com

FC specifications

	3125 DF	3525 DF	3125 RF	3525 RF
Working width per cutting unit (m)	3.10	3.50	3.10	3.50
Possible working widths of combinations (m)	-			
Overlapping front/rear unit (cm)	30-50 (FC 8830/9530)	50-70 (FC 8830/9530) / 30-50 (FC 10030)	30-50 (FC 8830/9530)	50-70 (FC 8830/9530) / 30-50 (FC 10030)
Swath width (m)**	1.20-2.00		1.40-2.00	
Attachment	3 point- Cat. 2			
PTO speed (min ⁻¹)	1,000			
Primary PTO shaft				
Free wheel	Integrated in the side gearbox			
Cutter bar				
Number of discs with safety skids made of hardened steel	7	8	7	8
Drive train				
Suspension				
Ground adaptation	Swivel rods			
Conditioning system	Pivoting steel fingers		2 SQUAREFLEX rollers in polyurethane	
Wide spreading	-			
Transport width (m)	2.99	3.48	2.99	3.48
Transport height (m)	-			
Side guards				
Machine storage	Flat			
Lighting and signalling				
Min. PTO power requirement (kW/hp)	50/68	57/77	50/68	57/77
Tractor hydraulic requirements	1 SA			
Weight (kg)	1,320	1,390	1,370	1,455

◆ as standard

* With linkage in minimum overlap position. Add 20 cm if 3.50 m front mower.

** Depending on crop.



be strong, be **KUHN**

KUHN PARTS

Designed and manufactured to rival time



KUHN foundries and forge as well as a high-level manufacturing process allow the production of spare parts to defy time. You can truly rely on our know-how and our genuine parts. Farmers benefit from our client support and logistics services via any KUHN PARTS warehouse, which provide quick and reliable repair solutions in cooperation with your nearest authorised KUHN dealer.



Disc mower conditioners

3115 D	3115 R	8830 D	9530 D	10030 D	8830 R	9530 R	10030 R
3.10		-					
5.96* (FC 3125)		8.73 - 8.33	9.53 - 9.13	9.93 - 9.53	8.73 - 8.33	9.53 - 9.13	9.93 - 9.53
26-41 (FC 3125) 46-61 (FC 3525)		30-50 (FC 3125 DF) / 50-70 (FC 3525 DF)		30-50 (FC 3525 DF)	30-50 (FC 3125 RF) / 50-70 (FC 3525 RF)		30-50 (FC 3525 RF)
1.45 - 2.10		2 x 1.45-2.10	2 x 1.85-2.40				
3 point- Cat. 3N		3 point- Cat. 3 ou 4N (compatible with Quick Hitch cat. 3/4N)					
1,000		1,000					
1 3/8" - or 21 splines with friction clutch							
				Integrated in the side gearboxes			
OPTIDISC ELITE							
7		2 x 7	2 x 8		2 x 7	2 x 8	
PROTECTADRIVE system							
LIFT-CONTROL hydro-pneumatic suspension							
Pendulum-type articulation							
Pivoting steel fingers	2 SQUAREFLEX ROLLERS in polyurethane	Pivoting steel fingers			2 SQUAREFLEX ROLLERS in polyurethane		
◆							
2.44		2.95		3.35	-	2.95	3.35
3.43		3.50	3.90		3.50	3.90	
FLEXPROTECT side guards							
Flat or vertical with extra parking stand		Flat or folded vertically					
◆							
50/68		140/191	154/210	162/221	140/191	154/210	162/221
1 SA + 1 DA		2 DA (+ 1 DA optional for 3-point hitch)					
1,475	1,530	3,030	3,210	3,260	3,150	3,330	3,380

KUHN SERVICES* Maximise the use and productivity of your KUHN equipment

*Not all services and equipment are available in every country.

KUHN sos order

EXPRESS SPARE PARTS SERVICE 24/7

You urgently need spare parts? With KUHN SOS order benefit from express delivery seven days a week, 365 days a year. Thus, you can minimise machine downtime considerably and increase your work output.

KUHN protect +

THE CHOICE OF PROFESSIONALS!

Benefit from 36 months in complete serenity because of KUHN's protect + warranty. You can concentrate exclusively on your work and the performance of your machine. Because this is what you expect, when investing in high-tech machinery.

KUHN i tech

FOR EVER QUICKER REPAIRS!

An unexpected technical problem always occurs at the wrong time. Your KUHN dealer can support you quickly and efficiently thanks to KUHN i tech. With this 24/7 online service, a quick and exact diagnosis is possible

KUHN finance

INVEST RATIONALLY!

New machine necessary, financing unsure? Modernise your equipment and develop your farm with KUHN finance, in total safety and according to your needs and demands. We offer custom-made finance solutions, adapted to your requirements.

MyKUH N

THE LINK TO SUCCESS

MyKUH N is your online portal. Join now and discover how MyKUH N exclusive services will make managing your KUH N fleet so much easier, especially hay/silage making.*

Go to: mykuhn.kuhn.com

Manage your fleet

All the tools you need online to make the most of your KUH N machines!

Simply log in to manage all your KUH N machines by getting direct access to spare parts and operator manuals.

Genuine parts:

With MyKUH N you can search for a part using its reference number or by looking in the KUH N parts e-catalog. It's so easy. You can see whether the part is available at your dealer's and place your order.

Operator manuals:

Enter your machines in the «my fleet» section to find the operator's manual you need. With MyKUH N you can download a printable version. MyKUH N will notify you directly when your machine needs an update. You can then contact your dealer. No more surprises, you'll be informed in time!



** Available in some countries*

Maximise your machine's performance

Optimise your machine settings

Access all settings and maintenance information when you need to, and optimise productivity.

Send your prescription map in a click

With KUHN EasyTransfer on your computer, send your prescription maps to your machines via the Agrirouter platform. Soon available on MyKUHN.

Let us guide you toward application rate modulation

With the KUHN EasyMaps application, adjust your application rate manually by viewing your prescription map and your field position directly on your smartphone.

Exclusive, expert news

MyKUHN has a wealth of high added-value information! Keep up-to-date on new KUHN machines and equipment, consult KUHN customer testimonials, get agronomical and technical advice from our experts and learn all about KUHN's know-how.

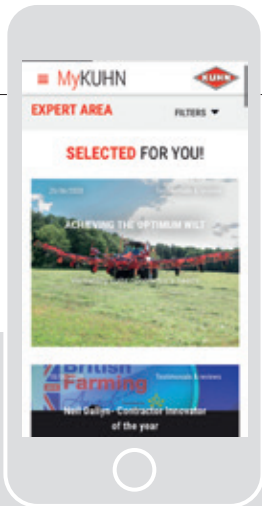

And many other great features...



Participate in events

Get notification when KUHN dealers organise events next to your farm and of other events not to be missed.



Benefit from machine offers

Get exclusive financing offers on KUHN parts and machines.



Stay in touch

Locate and save your favorite dealers so you can get in touch whenever you want!

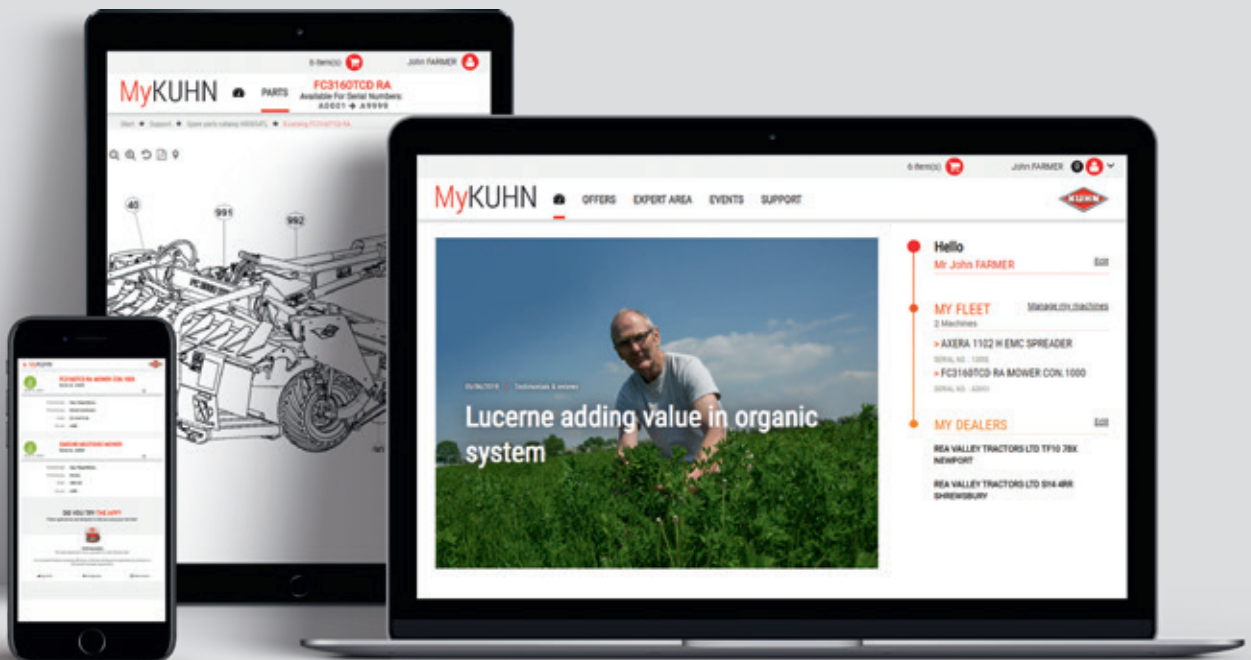

KUHN

APPS

CHECK OUT THE RANGE OF HAY AND SILAGE MAKING TOOLS

Check out the extensive KUHN range for large grassland operations!



1. Gyrotedders up to 17 m 2. Twin-rotor Gyrorakes 3. Four-rotor Gyrorakes 4. Belt mergers up to 13 m

For more information about your nearest KUHN dealer, visit our website www.kuhn.com



Retrouvez-nous sur nos chaînes YouTube.

 <p>www.kuhn.com</p>	<p>Your KUHN dealer</p>
--	-------------------------

KUHN SAS

4 Impasse des Fabriques - BP 50060
F-67706 Saverne CEDEX - FRANCE

KUHN NORTH AMERICA, INC.

1501 West Seventh Avenue - Brodhead,
WI 53520 - USA

KUHN FARM MACHINERY PTY. LTD

313-325 Foleys Road - Deer Park, VIC, 3023 - AUSTRALIA

KUHN FARM MACHINERY (U.K.) LTD

Stafford Park 7 - GB TELFORD/ SHROPS TF3 3BQ

Information given in this document is only for information purposes and is non-contractual. Our machines are in compliance with regulations in force in the country of delivery. In our literature, and for improved illustration of certain details, some safety devices may not be in operating position. When operating these machines, these devices must be in position in accordance with the requirements indicated in the operator's manuals and assembly manuals. Respect the tractor gross vehicle weight rating, its lift capacity and maximum load per axle and tyres. The tractor front axle load must always comply with the regulations of the country of delivery (In Europe, it must reach minimum 20 % of the tractor net weight). We reserve the right to change any designs, specifications or materials listed without further notice. Machines and equipment in this document can be covered by at least one patent and/or registered design. Trademarks cited in this document may be registered in one or several countries.

Also find KUHN on  